

Attachment Illustrated Parts List



Attachment

Mfg. No. Description
1694924 Turbo Collector Regent, 44" & 50" Mower

Simplicity

MANUFACTURING, INC.
500 N. Spring Street / PO Box 997
Port Washington, WI 53074-0997 USA

www.simplicitymfg.com

© Copyright 2007 Simplicity Manufacturing, Inc. All Rights Reserved. Printed In USA.

Part No.: 1734823

Rev. 10/2007

TP 400-4544-01-AT-SMA

PRODUCT COMPONENTS	PAGES
Turbo, Blower	4
Turbo, Mounting Kit	6
Torque Specification Chart	Inside Back Cover

Turbo, Blower

987376

NOTE: Unless noted otherwise,
use the standard hardware torque
specification chart.

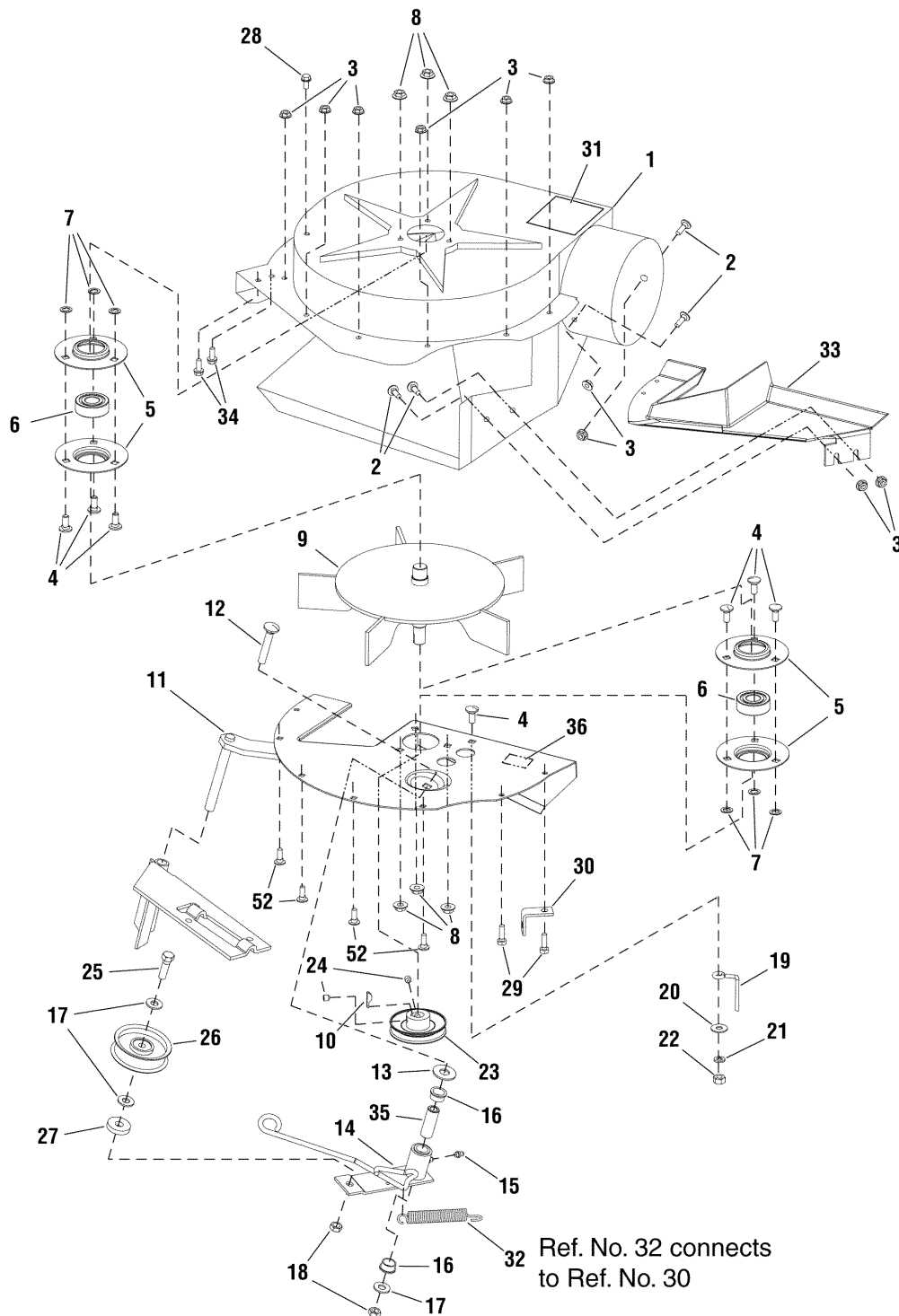

The above parts group applies to the following Mfg. Nos.:

1694924 - Turbo Collector Regen

Turbo, Blower

REF NO	PART NO.	QTY.	DESCRIPTION
1	1724441SM	1	HOUSING FAN ASSEMBLY
2	1931317SM	4	BOLT, Carriage, 1/4 - 20 x 3/4
3	1930641SM	10	NUT, Hex Flange Whiz Lock, 1/4 - 20
4	1931333SM	7	BOLT, Carriage, 5/16 -18 x 3/4
5	1665982ASM	4	RETAINER, Bearing
6	2108202SM	2	BEARING
7	1933988SM	6	PUSH NUT, 5/16
8	1927557SM	6	NUT, Hex Flange Whiz Lock
9	1706631ASM	1	FAN ASSEMBLY, Five Paddle
10	2860403SM	1	KEY, Woodruff
11	1706465ASM	1	PLATE ASSEMBLY
12	1931355SM	1	BOLT, Carriage, 3/8 -16
13	1924361SM	1	WASHER, Flat
14	1706284ASM	1	LEVER ASSEMBLY, Turbo
15	2821133SM	1	FITTING, Lube
16	1676148SM	2	BUSHING
17	1924940SM	3	WASHER, Flat
18	1960251SM	2	NUT, Hex Center Lock Jam, 3/8 - 16
19	1678435SM	1	BELT, Stop
20	1924874SM	1	WASHER, Flat
21	1917356SM	1	LOCKWASHER, 5/16
22	1917372SM	1	NUT, Hex, 5/16 - 18
23	1706634SM	1	PULLEY ASSEMBLY IDLER
24	1960619SM	2	SETSCREW, Torx
25	1920415SM	1	CAPSCREW, Hex Head, 3/8 - 16 x 1-1/4
26	2154534SM	1	PULLEY ASSEMBLY IDLER
27	1933263SM	1	WASHER, Flat
28	1925003SM	1	SCREW, Washer Head Taptite, 1/4 - 20 x 1/2
29	1924009SM	2	CAPSCREW, Hex Head, 1/4 - 20 x 7/8
30	1668500SM	1	ANCHOR, Spring
31	1700259SM	1	DECAL, Danger (Included with Ref. No. 1)
32	1716853SM	1	SPRING, Tension
33	1705267SM	1	PLATE, Cover
34	1960728SM	2	SCREW, Hex Washer Head, 1/4 x 3/4
35	1676833SM	1	SPACER
36	1713057SM	1	DECAL, Patent
52	1921959SM	4	CAPSCREW, 1/4 - 20 x 5/8

Footnotes

The above parts group applies to the following Mfg. Nos.:

1694924 - Turbo Collector Regen

Turbo, Mounting Kit

987368

NOTE: Unless noted otherwise, use the standard hardware torque specification chart.

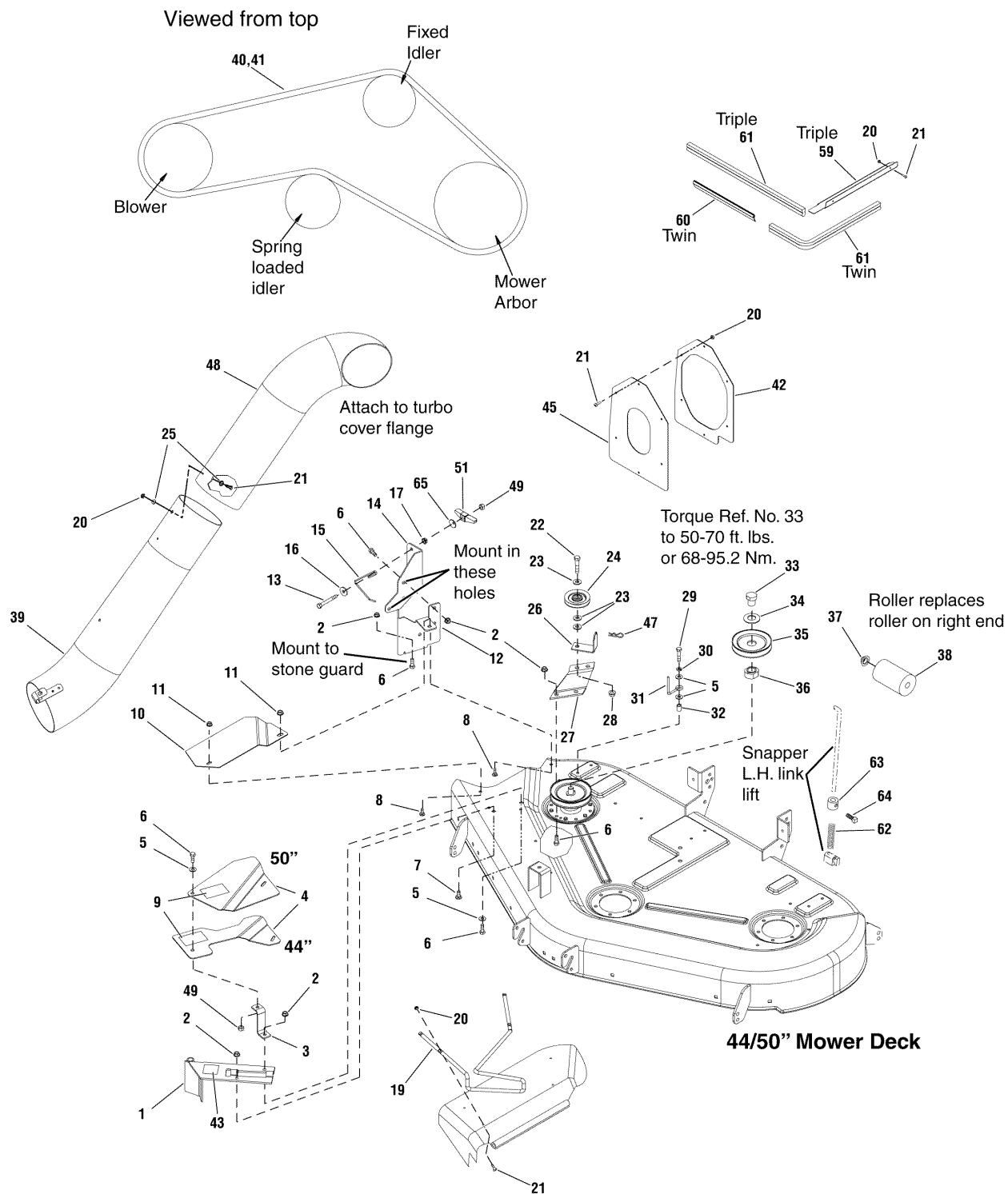

The above parts group applies to the following Mfg. Nos.:
1694924 - Turbo Collector Regen

Turbo, Mounting Kit

REF NO	PART NO.	QTY.	DESCRIPTION
1	1722546ASM	1	PIVOT BRACKET ASSEMBLY
2	1931277SM	7	NUT, Hex Whiz Lock Flange, 5/16 - 18
3	1718304ASM	1	SUPPORT, Belt Cover
4	1724374ASM	1	COVER, Belt, 44"
4	1724376ASM	1	COVER, Belt, 50"
5	1919326SM	4	WASHER, Flat, 5/16
6	1923325SM	7	CAPSCREW, Hex, 5/16 - 18 x 7/8
7	1931333SM	1	BOLT, Carriage, 5/16 - 18 x 3/4
8	1931317SM	2	BOLT, Carriage, 1/4 - 20 x 3/4
9	1717291SM	2	DECAL, Warning
10	1732591ASM	1	COVER, Mower
11	1960685SM	2	NUT, Keps Conical, 1/4 - 20
12	1732592ASM	1	BRACKET, Baffle
13	1960318SM	1	CAPSCREW, Hex, 5/16 - 18 x 2-1/2
14	1732619ASM	1	BAFFLE, Turbo
15	1705064SM	1	SPRING, Latch
16	1919381SM	1	WASHER, 5/16
17	1960636SM	1	NUT, Keps Lock, 5/16 - 18
19	1718295ASM	1	ROD, Deflector
20	1933896SM	13	NUT, ESNA Lock, 10 - 24
21	1960404SM	13	SCREW, Truss Phillips, 10 - 24 x 3/4
22	1923701SM	1	CAPSCREW, Hex, 3/8 - 16 x 2
23	1924940SM	3	WASHER, Flat, 3/8
24	1714817SM	1	PULLEY, Idler, 2-3/4
25	1910531SM	2	WASHER, Flat
26	1724373ASM	1	BRACKET, "L"
27	1704768ASM	1	BRACKET, "Z"
28	1931211SM	1	NUT, Whiz Lock Small, 3/8 - 16
29	1921221SM	1	CAPSCREW, Hex, 5/16 - 18 x 1-1/2
30	1917356SM	1	LOCKWASHER, 5/16
31	2172845SM	1	STOP, Belt
32	1710703SM	1	SPACER
33	1733078SM	1	NUT, Short Sleeve
34	1603592SM	1	WASHER, Flat, 7/8
35	1709941SM	1	PULLEY, 4.3
36	1713623SM	1	HUB, Double, 5/8
37	1960520SM	1	NUT, Push
38	1713540SM	1	ROLLER
39	1719719SM	1	TUBE ASSEMBLY, Lower
40	1732801SM	1	V-BELT, 39.62 (50" Mower Decks)
41	1732945SM	1	V-BELT, 37.9 (44" Mower Decks)
42	1732735ASM	1	SEAL, Flange
43	1713057SM	1	DECAL, Patent
45	1733741SM	1	SEAL, Cover

Footnotes

The above parts group applies to the following Mfg. Nos.:

1694924 - Turbo Collector Regen

Turbo, Mounting Kit

987368

NOTE: Unless noted otherwise, use the standard hardware torque specification chart.

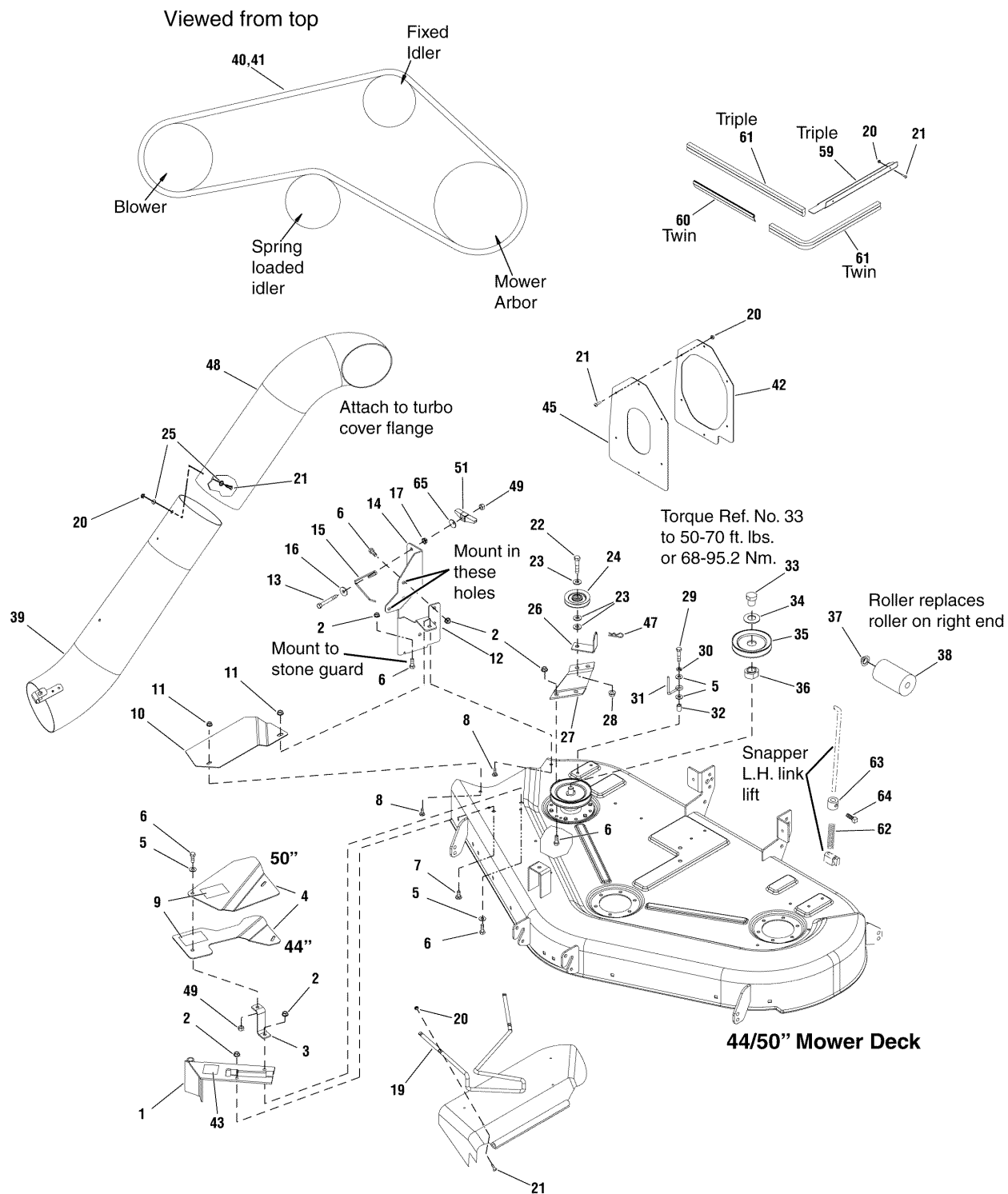

The above parts group applies to the following Mfg. Nos.:
1694924 - Turbo Collector Regen

Turbo, Mounting Kit

REF NO	PART NO.	QTY.	DESCRIPTION
47	1960074SM	1	PIN, Klik
48	1732800SM	1	TUBE, Upper
49	1919438SM	2	NUT, ESNA, 5/16 - 18
51	071294MA	1	WINGNUT
59	1733580ASM	1	PLATE, Deflector
60	1717496SM	1	SEAL, Rubber
61	1733579SM	1	SEAL, Rubber
62	1729277SM	1	SPRING, Compression (For Use On Snapper Models)
63	1719777SM	1	COLLAR, Locking (For Use On Snapper Models)
64	1928721SM	1	SCREW, Set, 5/16 - 19 (For Use On Snapper Models)
65	1709256SM	1	WASHER, Spring Cup
--	1660934SM	1	HARDWARE BAG
--	1732839	1	INSTALLATION INSTRUCTIONS

Footnotes

The above parts group applies to the following Mfg. Nos.:

1694924 - Turbo Collector Regen

Hardware Identification & Torque Specifications

Common Hardware Types

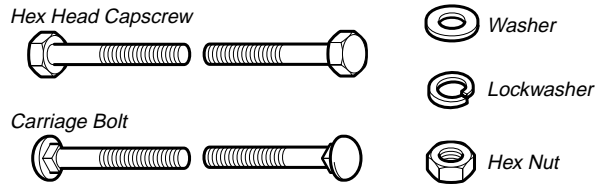

Standard Hardware Sizing

When a washer or nut is identified as **1/2"**, this is the *Nominal size*, meaning the *inside diameter* is 1/2 inch; if a second number is present it represent the *threads per inch*

When bolt or capscrew is identified as **1/2 - 16 x 2"**, this means the *Nominal size*, or *body diameter* is 1/2 inch; the second number represents the *threads per inch* (16 in this example, and the final number is the *body length* of the bolt or screw (in this example 2 inches long).

The guides and ruler furnished below are designed to help you select the appropriate hardware and tools.

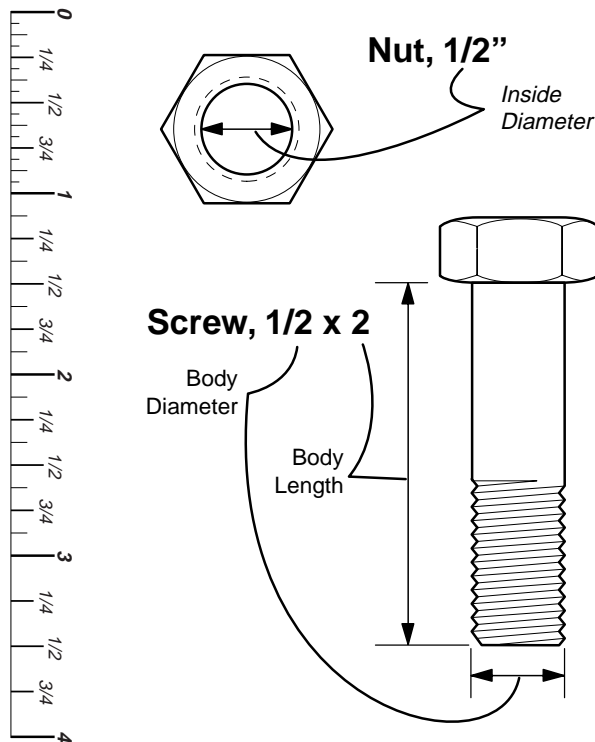

Torque Specification Chart						
FOR STANDARD MACHINE HARDWARE (Tolerance ± 20%)						
Hardware Grade	No Marks SAE Grade 2		SAE Grade 5		SAE Grade 8	
	in/lbs ft/lbs	Nm.	in/lbs ft/lbs	Nm.	in/lbs ft/lbs	Nm.
8-32	19	2.1	30	3.4	41	4.6
8-36	20	2.3	31	3.5	43	4.9
10-24	27	3.1	43	4.9	60	6.8
10-32	31	3.5	49	5.5	68	7.7
1/4-20	66	7.6	8	10.9	12	16.3
1/4-28	76	8.6	10	13.6	14	19.0
5/16-18	11	15.0	17	23.1	25	34.0
5/16-24	12	16.3	19	25.8	27	34.0
3/8-16	20	27.2	30	40.8	45	61.2
3/8-24	23	31.3	35	47.6	50	68.0
7/16-14	30	40.8	50	68.0	70	95.2
7/16-20	35	47.6	55	74.8	80	108.8
1/2-13	50	68.0	75	102.0	110	149.6
1/2-20	55	74.8	90	122.4	120	163.2
9/16-12	65	88.4	110	149.6	150	204.0
9/16-18	75	102.0	120	163.2	170	231.2
5/8-11	90	122.4	150	204.0	220	299.2
5/8-18	100	136	180	244.8	240	326.4
3/4-10	160	217.6	260	353.6	386	525.0
3/4-16	180	244.8	300	408.0	420	571.2
7/8-9	140	190.4	400	544.0	600	816.0
7/8-14	155	210.8	440	598.4	660	897.6
1-8	220	299.2	580	788.8	900	1,244.0
1-12	240	326.4	640	870.4	1,000	1,360.0

NOTES

- These torque values are to be used for all hardware excluding: locknuts, self-tapping screws, thread forming screws, sheet metal screws and socket head setscrews.
- Recommended seating torque values for locknuts:
 - for prevailing torque locknuts - use 65% of grade 5 torques.
 - for flange whizlock nuts and screws - use 135% of grade 5 torques.
- Unless otherwise noted on assembly drawings, all torque values must meet this specification.

Wrench & Fastener Size Guide



1/4" Bolt or Nut
Wrench—7/16"

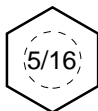

5/16" Bolt or Nut
Wrench—1/2"

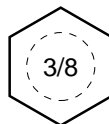

3/8" Bolt or Nut
Wrench—9/16"



7/16" Bolt or Nut
Wrench (Bolt)—5/8"
Wrench (Nut)—11/16"

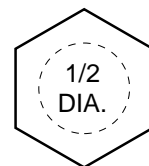

1/2" Bolt or Nut
Wrench—3/4"

